

Development of Automatic Change-Over with Auto-Start Timer and Artificial Intelligent Generator

Yinusa Abdullahi^{1,*}, Ankit Bhardwaj², J. Rahila³, P. Anand⁴, Kishore Kandepu⁵

¹Department of Electrical and Electronics Engineering, Olabisi Onabanjo University, Ago-Iwoye, Ogun State, Nigeria.

²Department of Computer Science and Engineering, University of Connecticut, Storrs, Connecticut, USA.

^{3,4}Department of Electrical and Electronics Engineering, Dhaanish Ahmed College of Engineering, Chennai, Tamil Nadu, India.

⁵Middleware Admin in JBOSS, WebSphere, AWS, Information Technology, Oberon IT Inc, Irving, Texas, USA.
yinusaabdullahi6@gmail.com¹, ankit.bhardwaj@uconn.edu², rahila@dhaanishcollege.in³, anand@dhaanishcollege.in⁴, kishore.kandepu@ieee.org⁵

Abstract: The need to digitize electronic devices and their ability to be automatically controlled cannot be overemphasized. There is a quest for automatic switching control between the Conventional Generating Set and the Utility Source of Electricity. This project aims to design and construct an automatic change-over switch with auto start and timer. Here is the device that selects the main power supply source to a home or depending on the available quarters. It is designed to select between two power sources: power supply by the utility and self-generated power. When there is a power supply from the utility, it connects the user to this source of supply (regardless of whether the user is running on self-generated power) and stops the generator if the user is already running on self-generated power. It turns on the generator immediately after the supply from the utility is taken off and switches the supply from the Utility Supply to the generator with the aid of a microprocessor. The design also features special control functions that can enhance the generator's usability and control. Hence, effort by men to intermittently excite Generators and change over supplies due to erratic supply of electricity is thereby reduced.

Keywords: Automation; Change-over; Generator; Times; Power System; Artificial Intelligence; Erratic Supply of Electricity; Conventional Generating Set; Digitize Electronic Devices.

Received on: 09/11/2022, **Revised on:** 19/12/2022, **Accepted on:** 26/02/2023, **Published on:** 06/03/2023

Cited by: Y. Abdullahi, A. Bhardwaj, J. Rahila, P. Anand, and K. Kandepu, "Development of Automatic Change-Over with Auto-Start Timer and Artificial Intelligent Generator," *FMDB Transactions on Sustainable Energy Sequence*, vol. 1, no. 1, pp. 11–26, 2023.

Copyright © 2023 Y. Abdullahi *et al.*, licensed to Fernando Martins De Bulhão (FMDB) Publishing Company. This is an open access article distributed under [CC BY-NC-SA 4.0](https://creativecommons.org/licenses/by-nc-sa/4.0/), which allows unlimited use, distribution, and reproduction in any medium with proper attribution.

1. Introduction

As the world is becoming increasingly digitalized, there has been a technological evolution of control systems in homes and other environments [6]. Today, we have automatic door openers, electric cooker timers, car anti-theft alarm systems, air conditioner temperature controllers, etc. This is made possible by developing intelligent digital circuits that can perform logical operations depending on the state of the pressure. A control system is a device that can take present and anticipate future decisions based on present and past conditions [7]. Control systems were originally restricted to industrial purposes where they perform varieties of functions such as production control, temperature control, pressure control, process control, etc., basically due to cost, but improvements in the processes involved in the production of the integrated circuit have made the design of intelligent control systems very cheap. To enhance the usefulness of control systems in homes, adapting them to simple and important domestic applications such as power source selection is worthwhile. This means designing a system that can select

*Corresponding author.

the power supply source to the home depending on the available options without human intervention. Such a system will not only select the power source depending on availability, [7] it will also help select the cheaper source of power (power supplied by the utility) and help stop the source of self-generated power when the user is running on such power.

1.1. Background

The background to this design is surfed due to the immense demand of the entire populace to have a Change-over that does not necessarily need human intervention. Before then, once the utility supply is cut, the user changes the supply to the Generating Set before turning on the same set. Also, when the supply from the Utility Company is available, the generator will be turned off, and the supply is manually changed to the available power. Regarding this, improvements to the procedure were suggested. When the notion of changing or automating the controlled to automated was identified, engineers got to work immediately and created this automatic switch to toggle over. However, there was such a high need for this technology that action had to be taken to keep up with the rising demand. But because it costs money to secure this equipment, the rise in demand outweighs the fall in supply. I started this study to learn how mass manufacturing could stifle the rise in demand or satisfy it. I now decided to continue working alone on this project to gain insight into the extent I can get it finished, lacking the aid of industrial equipment. After receiving authorization, we evaluated the components and conducted marketplace research while carefully studying the circuit design. The equipment's rating was also taken into account. Numerous decisions were based on our primary supply source's erratic and inconsistent character. The system's acquisition costs were calculated, and they were discovered to be low and simple to use [1]. Users can experience supply and demand changes without additional labor or input. With all of these factors and research, we decided to create this project.

2. Review of Related works of Literature

Automatic change-over systems exist in the Nigerian market as the more popular automatic mains failure (AMF) systems suited for industrial use. They are expensive, used more by industries, and only a few individuals can afford to buy them. In order to bring something of such importance to the home front, students in various tertiary institutions in Nigeria took it as a responsibility to explore the development of this device, and thus, over the years, design and construction of an automatic change-over is a project topic that has been explored on different grounds by students of various tertiary institutions in Nigeria. However, this project topic has been limited to switching from the utility source to the generator source and vice versa. Improvements need to be made to make the project a more worthwhile work. Because of this, the design described in this project report adds an auto start, timer functionality, and a generator auto-off to the design of an automatic change-over system, making the system more advanced and useful to its user.

2.1. Components Used

- Transistor
- Relays
- Capacitors
- Resistors
- Voltage Regulators
- Step down transformer
- Bridge Rectifier
- Micro Controller
- Diode
- Power supply
- Indicator Light
- Timer
- Power Cable
- Triac

2.2. Control systems

Control systems are the heart of modern industrialization [5]. A control system consists of a set of devices to regulate and conclude the operation of another system. Control systems are used to maintain a constant output from the system being controlled or to control a system from one state to another when a condition is satisfied. Two common classes of control systems are logic or sequential control systems and linear or feedback control systems [2]. Control systems range from simple switches to complex and intelligent circuits and have existed since human civilization began. While old control systems rely on mechanical components such as pulleys and levers to perform their operation, modern control systems [5] utilize electronic components to replace mechanical components, which can be done without affecting their function. In an automatic logic control system, the control system may excite a series of mechanical actuators in the correct sequence to perform a task. As an instance, a control system may be used to fold a container, fill it with product, and seal it in an automatic sealing machine. Fuzzy logic control systems are another type of control system that combines both logic and linear control systems [3]. Open loop systems are one of the two types of linear control system and the second are closed loop systems. An open-loop control system does not have a feedback path, while a closed-loop system will always have a feedback path.

2.3. Power Controllers

Power controllers range from simple to complex devices that control the power delivered to a load [9]. An example of a simple power controller is a switch, which can be used to control when power needs to be delivered to a load, while an example of a complex power controller is ac-ac controller or chopper often employed in industries to control the AC power delivered to a load. Other power controllers include; rectifiers, earth leakage circuit breakers, over-current circuit breakers, and over-voltage circuit breakers. Some power controllers employ mechanical switches to switch the power supply from one state to another whenever a condition is satisfied. These mechanical switches include relays and contactors. An example of such a power controller is the automatic change-over system (the design in this project) that tends to switch the supply of a building to a standby generator whenever there is an interruption in the supply from the utilities [9]. Advanced power controllers employ microcontroller-based electronic systems for intelligently controlling power. Such systems improve the user's quality of life and help protect against downtime in industries and many electrical hazards that may cost electricity users a couple of million.

2.4. Transistors

A transistor is a three-terminal device that can be used as a signal switch or amplifier. Transistors are divided into two basic groups. These are BJT (bipolar junction transistor) and FET (field effect transistor) [10]. BJTs are current controlled devices with three terminals: collector, base, and emitter. BJTs are further classified into NPN and PNP types, with the differences emanating from the materials used to make the transistors, but both types operate on the same principle. FETs are voltage-controlled devices with three terminals as well. These terminals are drain, source, and gate. A small gate's voltage can be used to direct a large current in the drain or amplified depending on the connection of the transistor [10]. FETs are divided into many families, among which are the JFET (junction field effect transistor, which is further divided into n-channel type and p-channel type), MOSFET (metallic oxide semiconductor field effect transistor, IGFET, etc. The picture and the diagrammatic symbol of an NPN transistor are shown figure 1.

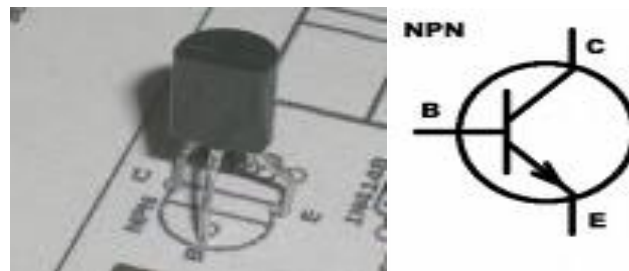

Figure 1: Picture and Diagrammatic Symbol of an NPN transistor [10]

2.5. Relay

A relay is an electromagnetic switch [8] in which an applied voltage can control two terminals. Every relay has five basic terminals. The common, normally closed, and normally open control voltage is applied to two other terminals. When voltage is applied to the input terminals (the voltage can be DC or AC depending on the type of relay), the applied voltage creates a magnetic field which causes a piece of metal attached to the common to be attracted from the normally closed to the normally open. This connects the common to the normally closed [8]. If one of the two terminals of an electrical material to be switched is linked to the common and the other terminal is linked to the normally open, applying a voltage to the input terminals of the relay will connect the two terminals. Thus, the relay achieves its switching function by applying a voltage between two of its terminals. Generally, the normally closed is usually designated NC, the common is usually designated C, and the normally open is designated NO. The picture and schematic representation of the relay are shown figure 2.

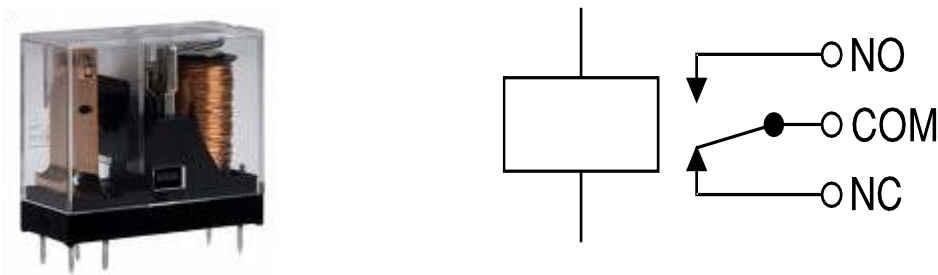

Figure 2: Picture and schematic representation of a relay [8]

2.6. Capacitors

A capacitor is a component capable of storing electric charge between its plates. It has two terminals which are connected to the plates. The plates are usually of opposite polarities to each other, and the polarity of each plate depends on the polarity of the voltage (external) fed to the terminals. The ability of a capacitor to store charge is a very useful phenomenon which makes the capacitor a very useful device found in many electronic and electrical applications. There are many types of capacitors, but they all fall into two major categories: polarized and unpolarized capacitors. Polarized capacitors have a differentiated positive and negative terminal; in unpolarized capacitors, any of the two terminals can be used as positive or negative terminals. The two types of capacitors used in this research work are the electrolytic and ceramic types.

The electrolytic type is a polarized capacitor used in the research to filter off ripples from the rectified output of the bridge rectifier [15]. The ceramic type is an unpolarized capacitor used to decouple the voltage regulator, i.e., eradicate the regulator from going into oscillation. Pictures of both types of capacitors and the schematic representation of both are shown figure 3.

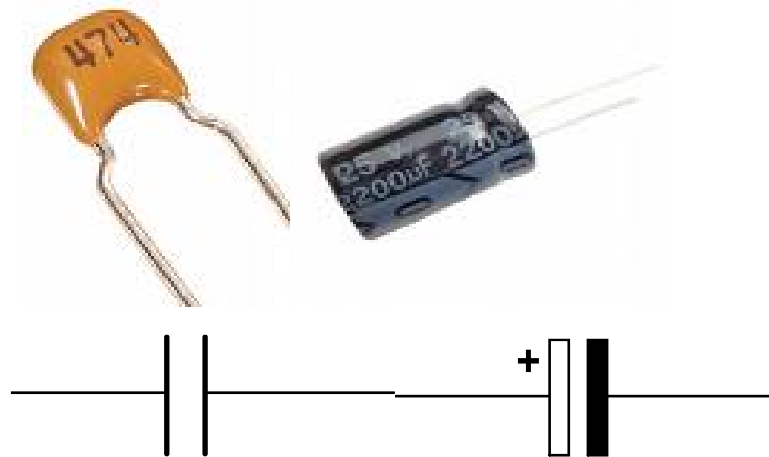

Figure 3: Pictures and schematic symbols of typical unpolarized and polarized capacitors [15]

2.7. Voltage regulators

Voltage regulators are devices that are designed specifically to maintain a constant voltage. Voltage regulators range from simple electronic components, such as the Zener diode, to integrated circuits, such as the 7805 voltage regulator, and finally to complex systems, such as the automatic voltage regulator used for stabilizing AC supply, which may contain many integrated circuits working together to perform the desired operation. In portable electronic circuits that operate at voltages of 18V and below, two popular classes of regulators are commonly used: the 78XX and 79XX voltage regulator series. The 78XX are positive voltage regulators that regulate the positive voltage to the ground to a desired level. The number XX denotes the constant output voltage level the regulator is designed to operate at [9]. Thus, we have 7805, 7806, 7808, etc., with voltage outputs of 5V, 6V and 8V respectively. The voltage (input) to the regulator must be a minimum of 3V higher than the output voltage level it is designed to deliver. The 79XX are negative voltage regulators used to regulate negative voltages to the ground. Like the 78XX series, the regulators are manufactured to supply different levels of regulated outputs and can withstand a maximum voltage of -24V to ground (figure 4).



Figure 4: The 7809-voltage regulator [9]

2.8. Step-down Transformer

A static device that transfers electric energy from one circuit to another by magnetic coupling. Their main use is to transfer energy between different voltage levels, which allows choosing the most appropriate voltage for power generation, transmission, and distribution separately [11]. Suppose a load is connected to the secondary. In that case, an electric current will flow in the secondary winding, and electrical energy will be transferred from the primary circuit through the transformer to the load. In an ideal transformer, the induced voltage in the secondary winding (V_S) is in proportion to the primary voltage (V_P) and is given by the ratio of the number of turns in the secondary (N_S) to the number of turns in the primary (N_P) as follows: By appropriate selection of the ratio of turns, a transformer can allow an ac voltage to be stepped up by making N_S greater than N_P or stepped down by making N_S less than N_P [12]. The 12volts step-down transformer used in this project is used for two functions. Step the mains supply voltage of 220 to 12 volts and isolate the electronic circuitry from the mains supply. The picture and schematic diagram of a transformer are shown figure 5.

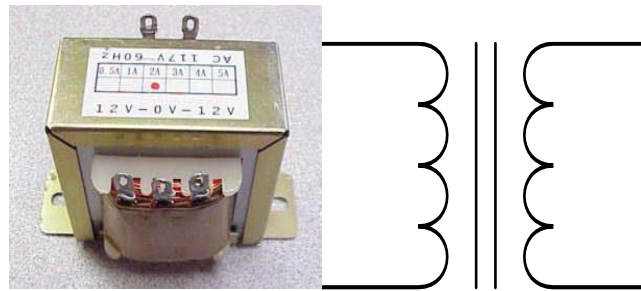

Figure 5: Picture and schematic representation of a transformer [12]

2.9. Bridge Rectifier

This special circuit contains four conventional diodes connected in the bridge configuration in a single package. It has the advantage of reduction in space, cost, and absolute maximum ratings than the conventional diodes connected in a bridge configuration on the circuit board. It is used in this project to rectify the AC output from the transformer secondary, i.e., change the alternating current output from the transformer secondary to direct current, which is the only form that can be properly used to power the electronic circuitry [13]. The picture and the schematic representation of the bridge rectifier are shown figure 6.

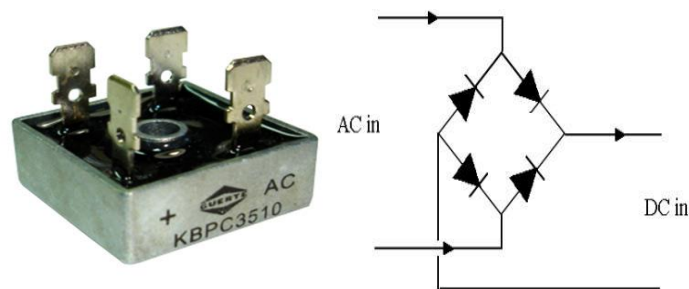

Figure 6: Picture of and schematic representation of a bridge rectifier [13]

2.10. Microcontrollers

A microcontroller is a microcomputer on a single chip [9]. A microcontroller has the processor, the memory (both RAM and ROM), and the I/O pins in a single chip. A microcontroller is a great technological tool as it brings a microcomputer's versatility and data-manipulating functions into a single chip of very little cost. This way, manufacturers of consumer technological products such as consumer electronics, automobiles, and others are provided with the opportunity to embed a digital computer into their products with little cost implication and without affecting the portability of the products. As a result, great control functions can be added to these products; hence, the quality of life and satisfaction derived from the products is increased.

However, the ROM and RAM sizes of most microcontrollers are very small, limiting them to only the applications they are used for in the product they are embedded in. There are many microcontrollers in the market by different manufacturers, but the leading manufacturer in the world of microcontrollers is Microchip, followed by Atmel. Microchip has many microcontrollers ranging from the 12CXX and 12FXX series to dsPICs. Microchip microcontrollers usually have the prefix PIC, meaning Programmable Interface Controller, preceding their names. For example, PIC16F84, PIC16F627, PIC16F628, PIC16F84A, PIC16F877, and many others are named similarly, all from Microchip (figure 7).



Figure 7: A microcontroller (PIC18F8720 from Microchip) on board. [9]

2.11. Diode

A diode is a two-terminal electronic component that conducts electricity in one direction. It has high resistance on one end and low resistance on the other end. [14]. The most popular kind of diode is a semiconductor diode. Only when a specific threshold voltage exists in the forward direction, also known as the "low resistance" direction, do these semiconductors start to conduct electricity. When the diode conducts current in this way, the term "forward biased" is used to describe it. The diode is referred to as being "reverse biased" when it is linked within a circuit in the opposite way (i.e., the "high resistance" direction). As the diode conducts current in this way, the term "forward biased" is used to describe it. The diode is referred to as being "reverse biased" when it is linked within a circuit in the opposite way (i.e., the "high resistance" direction). Once a diode is reverse-biased and the reverse voltage is within a certain range, it only prevents current from flowing in the opposite direction [15]. The reversal barrier breaks above this range. The "reverse breakdown voltage" is the voltage at which this breakdown occurs. The diode can conduct electricity in the reverse direction (sometimes known as the "high resistance" direction) when the circuit voltage exceeds the reverse breakdown voltage. Diodes have a high resistance in the opposite direction because of this in real life.

Below is a representation of a diode's symbol. The arrowhead in the forward biased condition points toward typical current flow. So, the cathode is connected to the n side, and the anode is attached to the p side. Doping a silicon or germanium crystal block with pentavalent or donor impurities in one portion and trivalent or acceptor impurities in the other allows us to make a straightforward PN junction diode. A PN junction is created by these dopings in the block's midsection [15]. We can also create a PN junction by fusing a p-type semiconductor and an n-type semiconductor using a unique production method. Anode refers to the terminal attached to the p-type. On the n-type side, there is a terminal that is the cathode (figure 8).

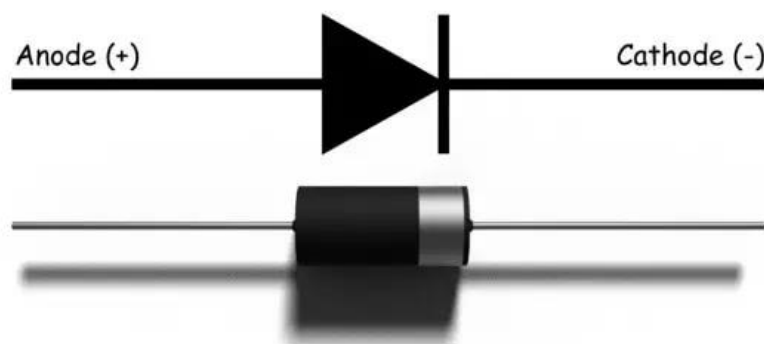

Figure 8: Symbol and Picture of a Diode [15]

2.12. Power supply

A power supply is an electronic device that feeds electric energy to an electrical load [16]. A power supply's primary function is to change one form of electrical energy to another. As a result, power supplies are sometimes referred to as electric power converters. Some power supplies are discrete, stand-alone devices, whereas others are built into larger devices along with their loads. Examples include power supplies found in desktop computers and consumer electronics devices. Every power supply must obtain the energy it supplies to its load [16] and any energy it consumes while performing that task from an energy source. Depending on its design, a power supply may obtain energy from various sources, including electrical energy transmission systems [16], energy storage devices such as batteries and fuel cells, electromechanical systems such as generators and alternators, solar power converters, or other power supplies.

2.13. Indicator light (LED)

An LED is an electronic device [17] that emits light when an electrical current is passed through it [17]. Early LEDs produced only red light, but modern LEDs can produce several colors, including red, green, and blue (RGB) light. Recent advances in LED technology have also made it possible for LEDs to produce white light. LEDs are commonly used for indicator lights (such as power on/off) on electronic devices. They also have several other applications, including electronic signs, clock displays, and flashlights) (figure 9).



Figure 9: Picture of Indicator Lights [17]

2.14. Timer

A timer switch (a time switch or simply a timer) is a timer [17] that operates an electric switch controlled by the timing mechanism. The switch may be connected to an electric circuit operating from mains power [18] via a relay, contactor, or low voltage, including battery-operated vehicle equipment. It may be built into power circuits (as with a central heating or water heater timer), plugged into a wall outlet with equipment plugged into the timer instead of directly into the PowerPoint, or built into equipment as, for example, a sleep timer that turns off a television receiver after a set period.

2.15. Power cable

A power cable is an electrical cable, an assembly of one or more electrical conductors [19], usually held together with an overall sheath. The assembly is used for the transmission of electrical power. Power cables may be installed as permanent wiring within buildings, buried in the ground, run overhead, or exposed. Flexible power cables are used for portable devices, mobile tools, and machinery.

2.16. Triac

Triac, derived from triode for AC, is a general trademark for a three-terminal electronic component [20] that infers current in either direction when excited. It is otherwise known as a bidirectional triode thyristor or bilateral triode thyristor. Thyristors are analogous to relays in that a small voltage and current can control a much larger voltage and current [21]. The illustration on the right shows the circuit symbol for a TRIAC where A1 is Anode 1, A2 is Anode 2, and G is Gate. Anode 1 and Anode 2 are normally termed Main Terminal 1 (MT1) and Main Terminal 2 (MT2) respectively. The TRIAC is a three-terminal semiconductor device for controlling current. It gains its name from the term TRI ode for Alternating Current [22]. It is effectively a development of the SCR or thyristor, but unlike the thyristor, which can only conduct in one direction, the TRIAC is a bidirectional device (figure 10).

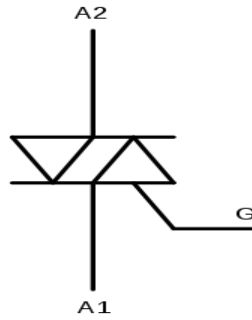

Figure 10: Picture of Triac [20]

2.17. Resistors

A resistor is a device [20] that obstructs the flow of electric current. Also, it is a device that can dissipate electrical energy as heat. The current through a resistor is a function of the resistor's resistance, as Ohm's law asserts [23]. There are various types of resistors, all of which fall into two main categories: fixed and variable resistors. Fixed resistors are resistors that have their values fixed from manufacture. The resistance of a fixed resistor is always constant [20]. Variable resistors are resistors with variable resistance values, i.e., the resistance value can be tuned to any desired value by the user [24]. The allowed resistance values usually fall within a range with a maximum value specified and a minimum value of approximately zero in all cases. Resistors perform two basic functions in all electronic circuits where they are found, which are the functions used in this research work [25]. These functions limit excessive current from getting to where it is not needed or where it can cause damage to the circuits, creating a voltage drop. The pictures and schematic diagrams of resistors are shown figure 11.

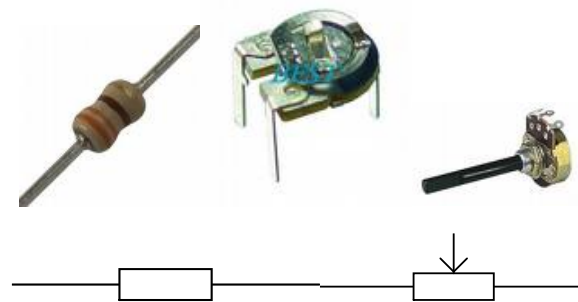

Figure 11: Pictures and schematic symbols of typical fixed and variable [20]

3. System Design and Methodology

3.1. Design concept

The design and construction of this project work comprises the following parts:

- The Electrical part
- The electronic/ microcontroller part.

3.2. The electrical part

- The electrical part is made up of two stages
- The power supply stage
- The power relay stage

3.2.1. The power supply stage

Two bridging rectifier circuits with voltage regulators [4] that allow regulating of their creates make up this level. The power relay stage is powered by the output of a single bridge rectifier circuit, which is used to rectify the incoming power from the utility company [26]. The inverter, infrared receiver, monostable, switching relay, and buzzer stages are all powered by the other bridge rectifier circuits, which are useful for rectification of the generator's input (power) (figure 12).

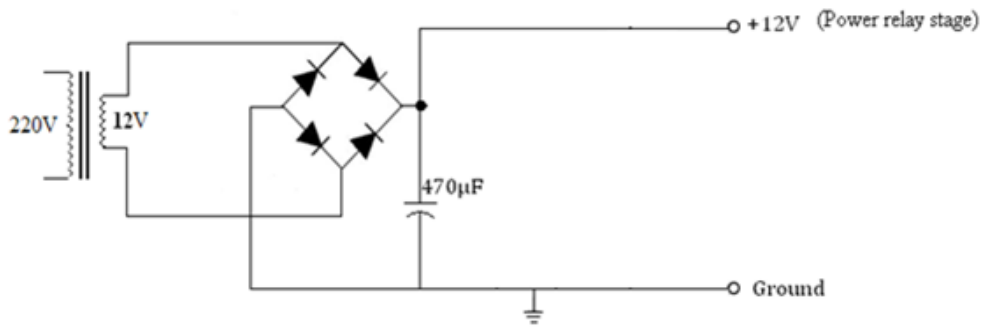

Figure 12: The power supply stage

As depicted in the circuit above,

Supply voltage, $V_s = 220\text{ V}$

Transformer Secondary Voltage, $V_{out} = 12\text{ V}$

The maximum output current $500\text{ mA} = 0.5\text{ A}$

Therefore, The Apparent Power, P required = IV

$$P = 12 \times 0.5 = 6\text{ VA}$$

$$I = C \frac{dV}{dt}$$

where, I = current rating of transformer = 500 mA

C = capacitance of the electrolytic capacitor

dV = rated value of d.c. Voltage of the transformer multiplied by $\sqrt{2}$ minus the voltage rating of the signal.

$dt = T$ = period of oscillation of the signal.

$I = 500\text{ mA}$;

$$dV_1 = 12\sqrt{2} - 12 = 4.97\text{ V}$$

$$dV_2 = 12\sqrt{2} - 5 = 11.970\text{ V}$$

$$dt = T = 1/f = 1/50\text{ Hz}$$

Using equation (1), the value of capacitor can be obtained as follows:

$$0.5 = 4.9C/0.02$$

$C_1 = 2012\mu\text{F}$, of which $2200\mu\text{F}$ is preferred.

The unregulated voltage output directly drives power relays.

3.2.2. The power relay stage

Two relays are part of this step [4], each powered by a portion of the power source connected to the utility supply. The product of this stage typically feeds the public utility supplier [27]. The output from the engine source to the utility provider is interrupted when supply from the utility company exists. At this juncture, the generator's actual supply to the Utility Company is under control [28]. In Figure 2, the circuit schematic for this level is displayed (figure 13).

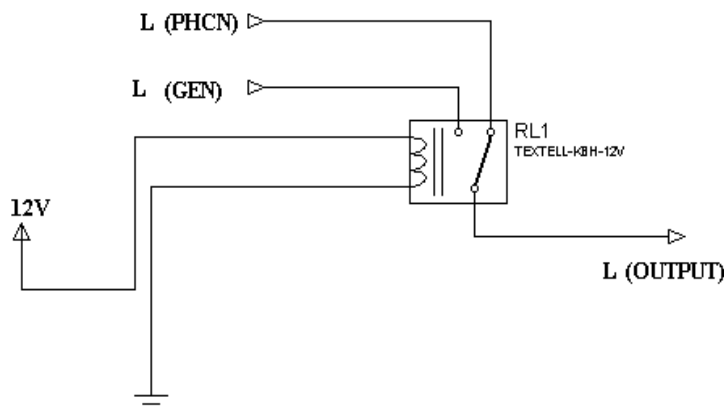

Figure 13: Power Relay Stage

3.3. The Electronic/ Microcontroller Part

This part comprises an electronic board with various components that work together to perform the function of timing and auto start. The major components on this board are the microcontroller, the switching relays and transistors, and the digital display [29]. The board is powered by a 12V battery, which can be taken from the generator or another 12V DC source [30]. The power for the microcontroller is generated by regulating the 12V input from the battery to 5V using a 7805 voltage regulator. The microcontroller is programmed, and the output is fed directly to the digital display. This means the digital display and the microcontroller operate programmatically [31]. The program is written in assembly and is provided in the appendix. The output of the microcontroller controls the switching relays [32]. The assembling of the relay and transistor is analyzed as thus:

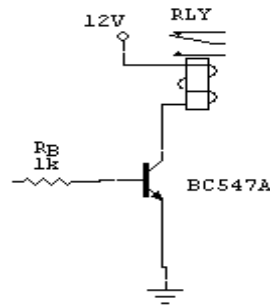

Figure 14: The switching relay

Figures 14 to 16 shows the complete circuit diagram of the design.

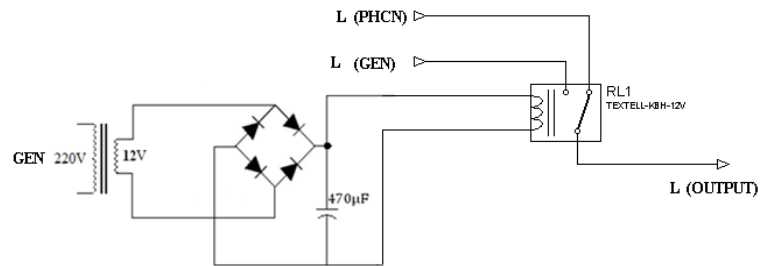

Figure 15: Circuit Diagram of The Electrical part

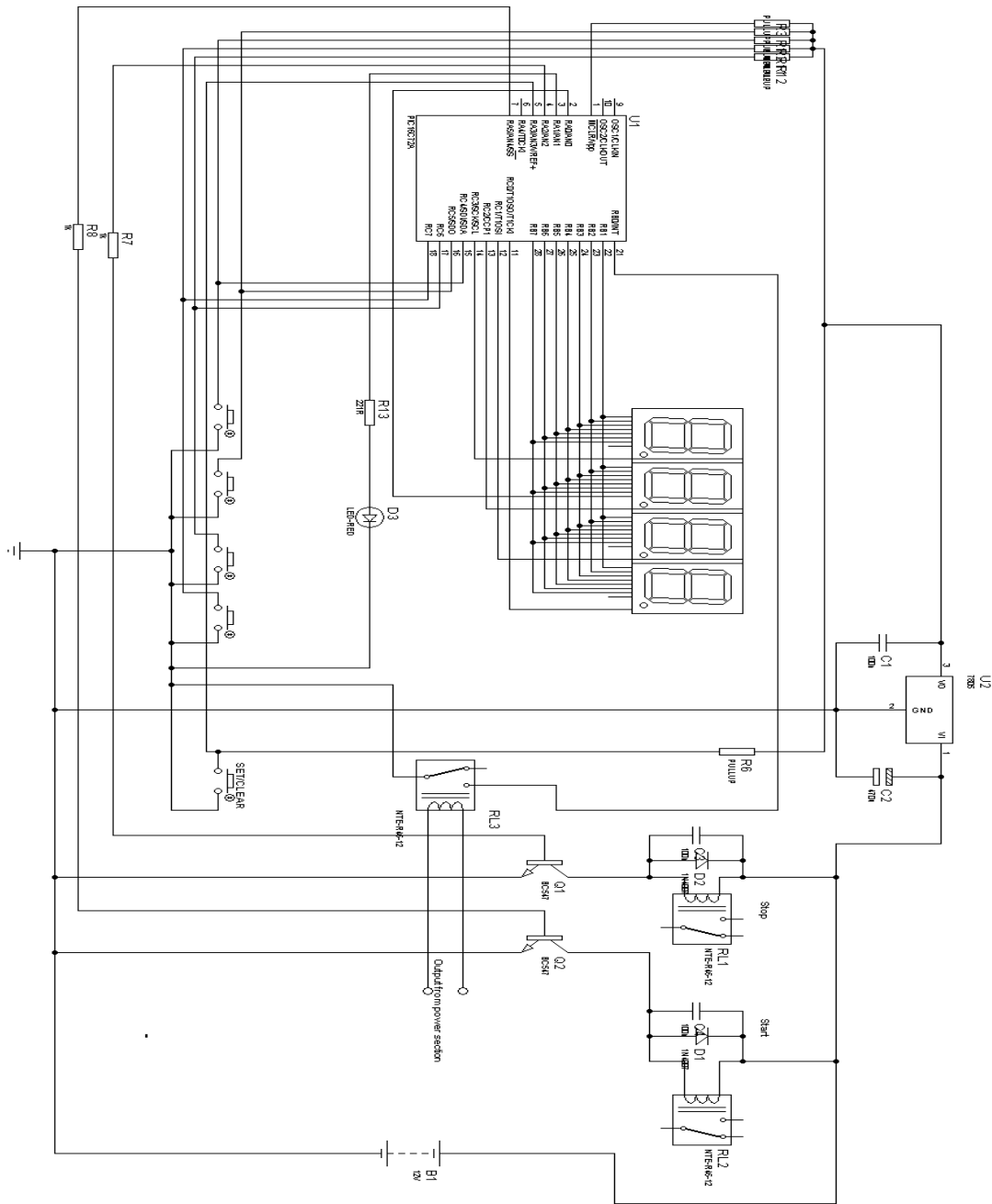

Figure 16: Circuit Diagram of The Electronic and Processor part

4. Construction, Testing and Observation

4.1. Construction

The steps involved in the design of this project are encapsulated in the pocketing and soldering phases. Explained in the forgoing are the two phases carried out.

4.1.1. Soldering

The soldering was done on a printed circuit board. The components were soldered properly, with the base of each component very close to the board's surface [33]. The components were placed on the board so that priority was given to space minimization and compactness. Links were created between the components with soldering lead and jumpers where they must be used. This gives room for minimizing circuit space at a very cheap cost [34]. The circuit was soldered in stages. This ensured that the objectives of space minimization and compactness were achieved [35]. This also ensures that the final circuit works properly without errors [36].

4.1.2. Precautions taken during the soldering

The Circuit board is held downward to place components on it. The components are hence soldered on the connection side. The optimum temperature of the soldering iron was ensured throughout the process to enable a very strong solder joint. The size of the connection paths was determined according to the amount of current that would flow through the path. Paths that will carry slightly high currents are bigger than those that will carry small currents [37]. A neat job on the circuit board was ensured by not using much solder on the components, as using such can lead to permanent damage to our workpiece. The microprocessor was placed inside the socket when the soldering was completed [38]. An adequate IC socket was then tightened using a soldering iron during soldering [39]. Decoupling capacitors were soldered physically very close to the voltage regulator so that they may serve the intended function [40].

4.1.3. Packaging

After all joints were soldered, the whole units were placed in a container. This container, the PVC, was chosen due to its predominant usage by Electrical Power Engineers during installation [41]. A Drilling Machine was also used to make holes in the surface of the container to allow the passage of wires confinement of switches and indicators [42]. Nuts and screws were used to make the necessary fittings on the container, and the Power transformer was placed firmly.

4.1.4. Precautions taken during the packaging

- Care was taken not to destroy the tracks when coupling the circuit to the container.
- Care was taken to ensure no connection between the coupling screws and any part of the circuit.
- Care was taken not to create a connection between two unconnected parts of the circuit while coupling.

4.2. Testing

Module testing was carried out on the device immediately after the soldering of each unit was completed. If proven abortive, the components are re-soldered to prevent open circuits [43]. After every phase had been soldered, the initial round of testing was conducted [44]. Test on the transformer was also carried out, and packaging took place with testing of the whole device.

4.3. Experimental results

The hypothetical setup was conducted in the classroom. The necessary components were chosen following the hardware design and specifications, and the component values were verified using a multimeter [45]. During the project's cause-and-effect testing, it was discovered that the generator started in 0.01 milliseconds, ran for 7 seconds before the load connected, and took 0.01 milliseconds to reconnect to the utility supply after power was restored [46]. The field experiment measured results were found to slightly deviate from the virtual ones after the project, as depicted in Table 1.

Table 1: The field experiment measured results

Labels	Simulated Results	Experimental Results	Comparison of The Variations
Power Supply (DC) Output	I = 1.21A V = 12.20V P = 14.76W	I = 1.09A V = 12.42V P = 13.54W	I = 0.12A V = 0.22V P = 0.026W
The output of the 555 timers	V = 12.15V	V = 12.04V	V = 0.11V
Cutoff Relay Output (Generator)	Proportional to the generator's input voltage	Proportional to the generator's input voltage	Proportional to the generator's input Voltage
Relay Output (Change-over)	Power from the respective power supply determines it	Power from the respective power supply determines it	Power from the respective power supply determines it.

5. Discussion

The findings of the simulated and experimental values when the system was under load are shown in Table 1. There were discrepancies between the output power, voltage, and current of the various models' simulations and experiments [47-51]. The variations were almost or practically negligible since the desired values of the component were somewhat used [52-54]. Using MATLAB, the power supply circuit's signal waveform is depicted in Figure 17, demonstrating that each design component is

given a DC current at all times [55-56]. The signal waveform of the connected load is depicted in Fig. 18, demonstrating that AC output current flows across all AC loads regardless of the source that supplies the load [57].

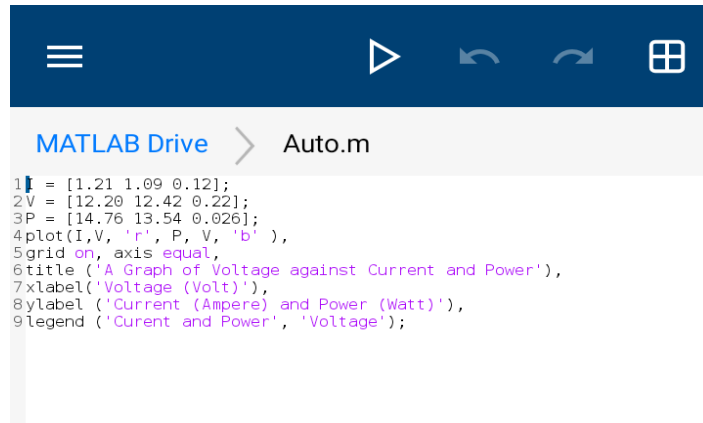

```

1 I = [1.21 1.09 0.12];
2 V = [12.20 12.42 0.22];
3 P = [14.76 13.54 0.026];
4 plot(I,V, 'r', P, V, 'b' ),
5 grid on, axis equal,
6 title ('A Graph of Voltage against Current and Power'),
7 xlabel('Voltage (Volt)'),
8 ylabel ('Current (Ampere) and Power (Watt)'),
9 legend ('Current and Power', 'Voltage');

```

Figure 17: The Picture of the Console Window in MATLAB

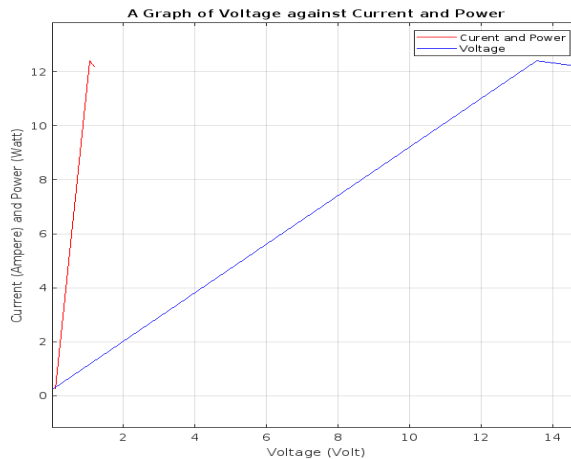

Figure 18: A Graph of Voltage (V) against Current (I) and Power (P) of Power Supply Output

6. Conclusion

Automatic change-over with Auto Start Timer and Generator is gaining significant demand due to its unaffordable advantages which include helping men reduce stress and a waste of time associated with turning on and stopping the alternative sources of supply (generating set). Each module of the system worked satisfactorily according to specifications. The automatic phase change-over switch is relatively affordable and reliable. It is easy to operate, and it controls the Line to the alternative Supply (Generator) when there is a power outage [8]. Further research for future developments and overload protection systems is recommended. The device is also recommended for areas where erratic electricity supply is highly discouraged, such as Medical Theatres and fields where electricity is needed. It is also advocated for small and medium entrepreneurs that the automatic change-over with Auto generator starting and shutting down facility will save their energy. It is also recommended to the government to aid the massive production of the device.

Acknowledgment: Support and guidance rendered by my supervisors, Engr. Raji Akeem Abimbola and Engr Afolabi, my Project Partners.

Data Availability Statement: The study collects literature data for experiments using Proteus to design circuits and MATLAB to interpret results. The corresponding author may be notified to provide data from this work.

Funding Statement: This study is supported by the Yunnan Intelligence Union Program (Grant NO. 202203AM140001).

Conflicts of Interest Statement: Authors collectively produce this work where they all agree with the work's points, issues, and findings.

Ethics and Consent Statement: This work is a draft from the corresponding author's Diploma Project. Supervisors and examiners mentioned in the acknowledgment approve the work before awarding a Diploma Degree to the candidate. Authors of the work unanimously consent to make this publication available to all interested people for reading, teaching, and learning.

References

1. <https://www.projecttopics.org>. Retrieved: 2/1/2023.
2. <https://www.Pnrsolution.org>. Retrieved: 4/2/2023.
3. www.Kupdf.net. Retrieved: 8/2/2023.
4. www.scribd.com. Retrieved: 2/3/2023.
5. R. J. Robles. "Security Encryption Scheme for Communication of Web Based Control Systems", Communications in Computer and Information Science, 2010.
6. <https://www.controleng.com/articles/the-impact-of-new-technologies-on-automation-and-digitalization-system-architectures/>. Retrieved: 2/3/2023.
7. <https://courses.lumenlearning.com/wm-principlesofmanagement/chapter/the-control-process/>. Retrieved: 15/3/2023
8. www.ijert.org. Retrieved: 22/3/2023.
9. www.researchgate.net. Retrieved: 3/4/2023.
10. www.instructables.com. Retrieved: 1/5/2023.
11. English Dictionary, 2016 Edition, extracted from the Wiktionary and available under the CC BY-SA 3.0 license.
12. <https://www.lawyersnjurists.com>. Retrieved: 20/2/2023.
13. A. U. Adoghe et al., "Construction and operation of an electronic automatic transfer switch (Ats)," Glob. J. Energy Technol. Res. Updates, vol. 2, no. 1, pp. 01–05, 2015.
14. <https://byjus.com/physics/diodes/>. Retrieved: 15/3/2023.
15. <https://www.electrical4u.com/diode-working-principle-and-types-of-diode/>. Retrieved: 7/4/2023.
16. khawerriaz.blogspot.com. Retrieved: 10/4/2023.
17. ArmstronglibRARY.org. Retrieved: 06/4/2023.
18. Jessicasiboro.blogspot.com. Retrieved: 14/4/2023.
19. en.Wikipedia.org. Retrieved: 20/4/2023.
20. M. S. Ahmed, A. S. Mohammed and O. B. Agusiobo, Development of a Single Phase Automatic Change-over Switch", Department of Electrical and Computer Engineering, F. U. T. Minna, Nigeria, July, 2006.
21. P. Paramasivan, "Comparative investigation of NiFe₂O₄ nano and microstructures for structural, optical, magnetic and catalytic properties," Advanced Science, Engineering and Medicine, vol. 8, pp. 392–397, 2016.
22. P. Paramasivan, S. Narayanan, and N. M. Faizee, "Enhancing Catalytic Activity of Mn₃O₄ by Selective Liquid Phase Oxidation of Benzyl Alcohol," Advanced Science, Engineering and Medicine, vol. 10, pp. 1–5, 2018.
23. S. Mishra and S. K. Samal, "An Efficient Model for Mitigating Power Transmission Congestion Using Novel Rescheduling Approach," Systems and Computers, 2023.
24. S. K. Samal and R. K. Khadanga, "A Novel Subspace Decomposition with Rotational Invariance Technique to Estimate Low-Frequency Oscillatory Modes of the Power Grid," Journal of Electrical and Computer Engineering, 2023.
25. A. Banu, S. M. Naidu, S. N. Vinjamuri, G. Dattu, M. Sridevi, and N. R. Chakravarthi, "Experimentally investigating the influence of static mixers on the performance of a solar water heater," Materials Today: Proceedings, vol. 62, no. 4, pp. 2370–2375, 2022.
26. A. K. Sahoo and S. K. Samal, "Online fault detection and classification of 3-phase long transmission line using machine learning model. Multiscale and Multidisciplinary Modeling," Experiments and Design, vol. 6, no. 1, pp. 135–146, 2023.
27. A. Patel, S. Samal, S. Ghosh, and B. Subudhi, "A study on wide-area controller design for inter-area oscillation damping," in 2016 2nd International Conference on Control, Instrumentation, Energy & Communication (CIEC), 2016.
28. B. Deepa, K. Gayathiridevi, M. Chakravarthi, A. Shajahan, and S. Sree, "Mohammed Imran Anees, Mohammad Habeeb, "Slow evaporation technique to grow 3 - Amino benzene sulfonic acid single crystal for Non-Linear optical (NLO) transmission"," Materials Today: Proceedings, vol. 62, no. 4, pp. 2119–2123, 2022.
29. B. Subudhi, S. K. Sarnal, and S. Ghosh, "A new low-frequency oscillatory modes estimation using TLS-ESPRIT and least mean squares sign-data (LMSSD) adaptive filtering," in TENCON 2017 - 2017 IEEE Region 10 Conference, 2017.

30. C. R. Mahesha et al., "Effect of friction stir welding on the mechanical and microstructural behaviour of AA7075 aluminium alloy," *Adv. Mater. Sci. Eng.*, vol. 2022, pp. 1–8, 2022.
31. D. Ganesh and M. K. Chakravarthi, "Remote Web Based Monitoring and Controlling Of a Nonlinear Process Using Micro Controller", in *IEEE, International Conference on Control, Instrumentation, Communication and Computational Technologies (ICCICCT-2014)*, 2014, pp. 826–829.
32. D. K. Sharma, B. Singh, M. Raja, R. Regin, and S. S. Rajest, "An Efficient Python Approach for Simulation of Poisson Distribution," in *2021 7th International Conference on Advanced Computing and Communication Systems (ICACCS)*, 2021.
33. D. K. Sharma, B. Singh, R. Regin, R. Steffi, and M. K. Chakravarthi, "Efficient Classification for Neural Machines Interpretations based on Mathematical models," in *2021 7th International Conference on Advanced Computing and Communication Systems (ICACCS)*, 2021.
34. D. K. Sharma, N. A. Jalil, R. Regin, S. S. Rajest, R. K. Tummala, and Thangadurai, "Predicting network congestion with machine learning," in *2021 2nd International Conference on Smart Electronics and Communication (ICOSEC)*, 2021.
35. D. Soni, M. Gagrani, A. Rathore, and M. K. Chakravarthi, "Study of Different Controller's Performance for a Real Time Non-Linear System," in *International Conference on Advances In Engineering And Technology - ICAET-2014*, 2014, pp. 171–175.
36. F. Arslan, B. Singh, D. K. Sharma, R. Regin, R. Steffi, and S. Suman Rajest, "Optimization technique approach to resolve food sustainability problems," in *2021 International Conference on Computational Intelligence and Knowledge Economy (ICCIKE)*, 2021.
37. G. A. Ogunmola, B. Singh, D. K. Sharma, R. Regin, S. S. Rajest, and N. Singh, "Involvement of distance measure in assessing and resolving efficiency environmental obstacles," in *2021 International Conference on Computational Intelligence and Knowledge Economy (ICCIKE)*, 2021.
38. G. P. Reddy, Y. V. P. Kumar, and M. K. Chakravarthi, "Communication technologies for interoperable smart microgrids in urban energy community: A broad review of the state of the art, challenges, and research perspectives," *Sensors (Basel)*, vol. 22, no. 15, 2022.
39. J. Pradhan, S. Panda, R. Kumar Mandal, and S. Kumar Panigrahi, "Influence of GGBFS-based blended precursor on fresh properties of self-compacting geopolymer concrete under ambient temperature," *Mater. Today*, 2023.
40. K. Sharma, B. Singh, E. Herman, R. Regine, S. S. Rajest, and V. P. Mishra, "Maximum information measure policies in reinforcement learning with deep energy-based model," in *2021 International Conference on Computational Intelligence and Knowledge Economy (ICCIKE)*, 2021.
41. L. Mohanty, S. K. Panigrahi, and M. Patnaik, "Assessment of water quality of Mahanadi basin using statistical and wavelet techniques," *Mater. Today*, vol. 62, pp. 6371–6378, 2022.
42. M. K. Chakravarthi and N. Venkatesan, "Experimental Transfer Function Based Multi-Loop Adaptive Shinskey PI Control For High Dimensional MIMO Systems", *Journal of Engineering Science and Technology*, vol. 16, no. 5, pp. 4006–4015, 2021.
43. M. Ravinder and V. Kulkarni, "A review on cyber security and anomaly detection perspectives of smart grid," in *2023 5th International Conference on Smart Systems and Inventive Technology (ICSSIT)*, 2023.
44. M. Ravinder and V. Kulkarni, "Intrusion detection in smart meters data using machine learning algorithms: A research report," *Front. Energy Res.*, vol. 11, 2023.
45. M. Siva Ramkumar et al., "Review and Evaluation of Power Devices and Semiconductor Materials Based on Si, SiC, and Ga-N," *Journal of Nanomaterials*, vol. 2022, 2022.
46. N. Verma, S. Patil, B. Sinha, and V. Kulkarni, "Object detection for COVID rules response and crowd analysis," in *2021 Innovations in Power and Advanced Computing Technologies (i-PACT)*, 2021.
47. P. K. Sahu, S. Maity, R. K. Mahakhuda, and S. K. Samal, "A fixed switching frequency sliding mode control for single-phase voltage source inverter," in *2014 International Conference on Circuits, Power and Computing Technologies [ICCPCT-2014]*, 2014.
48. P. Reddy, Y. Gogulamudi, and A. Maddikera Kalyan Chakravarthi, "Refined Network Topology for Improved Reliability and Enhanced Dijkstra Algorithm for Optimal Path Selection during Link Failures in Cluster Microgrids," *Sustainability*, vol. 14, no. 16, 2022.
49. R. Das, S. Panda, A. Saumendra Sahoo, and S. Kumar Panigrahi, "Effect of superplasticizer types and dosage on the flow characteristics of GGBFS based self-compacting geopolymer concrete," *Mater. Today*, 2023.
50. R. Jain et al., "Internet of Things-based smart vehicles design of bio-inspired algorithms using artificial intelligence charging system," *Nonlinear Eng.*, vol. 11, no. 1, pp. 582–589, 2022.
51. R. Sreehari and M. K. Chakravarthi, "Industrial Pollution Monitoring GUI System using Internet, LabVIEW AND GSM", *IEEE, International Conference on Control, Instrumentation, Communication and Computational Technologies (ICCICCT-2014)*, pp. 846–850, 2014.

52. S. Buragadda, K. S. Rani, S. V. Vasantha, M. K. Chakravarthi, and Hcugan, "HCUGAN: Hybrid Cyclic UNET GAN for Generating Augmented Synthetic Images of Chest X-Ray Images for Multi Classification of Lung Diseases"," International Journal of Engineering Trends and Technology, vol. 70, no. 2, pp. 229–238, 2022.
53. S. Gowtham et al., "A Survey on Additively Manufactured Nanocomposite Biomaterial for Orthopaedic Applications," Journal of Nanomaterials, vol. 2022, 2022.
54. S. K. Parhi and S. K. Panigrahi, "Alkali-silica reaction expansion prediction in concrete using hybrid metaheuristic optimized machine learning algorithms," Asian Journal of Civil Engineering, pp. 1–23, 2023.
55. S. K. Parhi, S. Dwibedy, S. Panda, and S. K. Panigrahi, "A comprehensive study on Controlled Low Strength Material," J. Build. Eng., vol. 76, no. 107086, p. 107086, 2023.
56. S. Mishra and S. K. Samal, "Impact of electrical power congestion and diverse transmission congestion issues in the electricity sector," Energy Syst., 2023.
57. S. Mishra and S. Kumar Samal, "Mitigation of transmission line jamming by price intrusion technique in competitive electricity market," Int. J. Ambient Energy, vol. 44, no. 1, pp. 171–176, 2023.